

# Inspiron 15

## 7000 Series

# Owner's Manual

Computer model: Inspiron 7537  
Regulatory model: P36F  
Regulatory type: P36F001



# Notes, Cautions, and Warnings



**NOTE:** A NOTE indicates important information that helps you make better use of your computer.



**CAUTION:** A CAUTION indicates potential damage to hardware or loss of data if instructions are not followed.



**WARNING:** A WARNING indicates a potential for property damage, personal injury, or death.

---

© 2013 Dell Inc.

Trademarks used in this text: Dell™, the DELL logo, and Inspiron™ are trademarks of Dell Inc.; Microsoft® and Windows® are registered trademarks of Microsoft corporation in the United States and/or other countries. Bluetooth® is a registered trademark owned by Bluetooth SIG, Inc. and is used by Dell under license.

# Contents

<b>Before Working Inside Your Computer</b> . . . . .	<b>7</b>
Before You Begin . . . . .	7
Recommended Tools. . . . .	7
Safety Instructions. . . . .	8
<b>After Working Inside Your Computer</b> . . . . .	<b>9</b>
<b>Removing the Base Cover</b> . . . . .	<b>10</b>
Procedure . . . . .	10
<b>Replacing the Base Cover</b> . . . . .	<b>11</b>
Procedure . . . . .	11
<b>Removing the Battery</b> . . . . .	<b>12</b>
Prerequisites. . . . .	12
Procedure . . . . .	12
<b>Replacing the Battery</b> . . . . .	<b>13</b>
Procedure . . . . .	13
Postrequisites. . . . .	13
<b>Removing the Memory Module(s)</b> . . . . .	<b>14</b>
Prerequisites. . . . .	14
Procedure . . . . .	14
<b>Replacing the Memory Module(s)</b> . . . . .	<b>15</b>
Procedure . . . . .	15
Postrequisites. . . . .	15
<b>Removing the Hard Drive</b> . . . . .	<b>16</b>
Prerequisites. . . . .	16
Procedure . . . . .	16
<b>Replacing the Hard Drive</b> . . . . .	<b>18</b>
Procedure . . . . .	18
Postrequisites. . . . .	18

<b>Removing the Wireless Card</b> . . . . .	<b>19</b>
Prerequisites. . . . .	19
Procedure . . . . .	19
<b>Replacing the Wireless Card</b> . . . . .	<b>20</b>
Procedure . . . . .	20
Postrequisites. . . . .	20
<b>Removing the Keyboard</b> . . . . .	<b>21</b>
Prerequisites. . . . .	21
Procedure . . . . .	21
<b>Replacing the Keyboard</b> . . . . .	<b>24</b>
Procedure . . . . .	24
Postrequisites. . . . .	24
<b>Removing the Bottom Cover</b> . . . . .	<b>25</b>
Prerequisites. . . . .	25
Procedure . . . . .	26
<b>Replacing the Bottom Cover.</b> . . . . .	<b>28</b>
Procedure . . . . .	28
Postrequisites. . . . .	28
<b>Removing the Coin-Cell Battery.</b> . . . . .	<b>29</b>
Prerequisites. . . . .	29
Procedure . . . . .	29
<b>Replacing the Coin-Cell Battery.</b> . . . . .	<b>30</b>
Procedure . . . . .	30
Postrequisites. . . . .	30
<b>Removing the Speakers</b> . . . . .	<b>31</b>
Prerequisites. . . . .	31
Procedure . . . . .	32
<b>Replacing the Speakers</b> . . . . .	<b>33</b>
Procedure . . . . .	33
Postrequisites. . . . .	33

<b>Removing the Thermal-Cooling Assembly . . . . .</b>	<b>34</b>
Prerequisites. . . . .	34
Procedure . . . . .	35
<b>Replacing the Thermal-Cooling Assembly . . . . .</b>	<b>36</b>
Procedure . . . . .	36
Postrequisites. . . . .	36
<b>Removing the USB Board . . . . .</b>	<b>37</b>
Prerequisites. . . . .	37
Procedure . . . . .	37
<b>Replacing the USB Board. . . . .</b>	<b>38</b>
Procedure . . . . .	38
Postrequisites. . . . .	38
<b>Removing the Power-Adapter Port . . . . .</b>	<b>39</b>
Prerequisites. . . . .	39
Procedure . . . . .	39
<b>Replacing the Power-Adapter Port . . . . .</b>	<b>43</b>
Procedure . . . . .	43
Postrequisites. . . . .	43
<b>Removing the System Board. . . . .</b>	<b>44</b>
Prerequisites. . . . .	44
Procedure . . . . .	45
<b>Replacing the System Board . . . . .</b>	<b>49</b>
Procedure . . . . .	49
Postrequisites. . . . .	49
Entering the Service Tag in the BIOS. . . . .	50
<b>Removing the Display Assembly. . . . .</b>	<b>51</b>
Prerequisites. . . . .	51
Procedure . . . . .	52
<b>Replacing the Display Assembly . . . . .</b>	<b>55</b>
Procedure . . . . .	55
Postrequisites. . . . .	55

<b>Removing the Display Bezel</b> . . . . .	<b>56</b>
Prerequisites. . . . .	56
Procedure . . . . .	57
<b>Replacing the Display Bezel</b> . . . . .	<b>59</b>
Procedure . . . . .	59
Postrequisites. . . . .	59
<b>Removing the Display Panel</b> . . . . .	<b>60</b>
Prerequisites. . . . .	60
Procedure . . . . .	61
<b>Replacing the Display Panel</b> . . . . .	<b>63</b>
Procedure . . . . .	63
Postrequisites. . . . .	63
<b>Removing the Display Hinges</b> . . . . .	<b>64</b>
Prerequisites. . . . .	64
Procedure . . . . .	65
<b>Replacing the Display Hinges</b> . . . . .	<b>66</b>
Procedure . . . . .	66
Postrequisites. . . . .	66
<b>Removing the Palm Rest</b> . . . . .	<b>67</b>
Prerequisites. . . . .	67
Procedure . . . . .	68
<b>Replacing the Palm Rest</b> . . . . .	<b>70</b>
Procedure . . . . .	70
Postrequisites. . . . .	70
<b>Flashing the BIOS.</b> . . . . .	<b>71</b>

# Before Working Inside Your Computer

---

## Before You Begin

 **CAUTION:** To avoid data loss, save and close all open files and exit all open programs before turning off your computer.

- 1 Save and close all open files, exit all open programs, and turn off your computer. Point to the lower or upper-right corner of the screen to open the Charms sidebar and click **Settings**→ **Power**→ **Shut down**.

 **NOTE:** If you use a different operating system, see the documentation of your operating system for shut-down instructions.

- 2 After the computer shuts down, disconnect it from the electrical outlet.
- 3 Disconnect all cables — such as power and USB cables — from your computer.
- 4 Disconnect all peripherals connected to your computer.









## Recommended Tools

The procedures in this document require the following tools:

- Phillips screwdriver
- Torx #5 (T5) screwdriver
- Plastic scribe

# Safety Instructions

Use the following safety guidelines to protect your computer from potential damage and ensure your personal safety.

-  **WARNING:** Before working inside your computer, read the safety information that shipped with your computer. For more safety best practices, see the Regulatory Compliance home page at [dell.com/regulatory\\_compliance](https://dell.com/regulatory_compliance).
-  **WARNING:** Disconnect all power sources before opening the computer cover or panels. After you finish working inside the computer, replace all covers, panels, and screws before connecting to the power source.
-  **CAUTION:** Only a certified service technician is authorized to remove the computer cover and access any of the components inside the computer. See the safety instructions for complete information about safety precautions, working inside your computer, and protecting against electrostatic discharge.
-  **CAUTION:** To avoid damaging the computer, make sure that the work surface is flat and clean.
-  **CAUTION:** When you disconnect a cable, pull on its connector or on its pull-tab, not on the cable itself. Some cables have connectors with locking tabs or thumb-screws that you must disengage before disconnecting the cable. When disconnecting cables, keep them evenly aligned to avoid bending any connector pins. When connecting cables, make sure that the ports and connectors are correctly oriented and aligned.
-  **CAUTION:** To avoid damaging the components and cards, handle them by their edges and avoid touching pins and contacts.
-  **CAUTION:** Before touching anything inside your computer, ground yourself by touching an unpainted metal surface, such as the metal at the back of the computer. While you work, periodically touch an unpainted metal surface to dissipate static electricity, which could harm internal components.
-  **CAUTION:** Press and eject any installed card from the media-card reader.



# After Working Inside Your Computer

---



**CAUTION: Leaving stray or loose screws inside your computer may severely damage your computer.**

- 1** Replace all screws and make sure that no stray screws remain inside your computer.
- 2** Connect any cables, peripherals, and other parts you removed before working on your computer.
- 3** Connect your computer to the electrical outlet.
- 4** Turn on your computer.

# Removing the Base Cover

---

**⚠ WARNING:** Before working inside your computer, read the safety information that shipped with your computer and follow the steps in "Before Working Inside Your Computer" on page 7. After working inside your computer, follow the instructions in "After Working Inside Your Computer" on page 9. For more safety best practices, see the Regulatory Compliance home page at [dell.com/regulatory\\_compliance](http://dell.com/regulatory_compliance).

## Procedure

- 1 Close the display, and turn the computer over.
- 2 Loosen the captive screws that secure the base cover to the palm-rest assembly.
- 3 Remove the screws that secure the base cover to the palm-rest assembly.
- 4 Using a plastic scribe, pry the base cover out of the bottom cover.

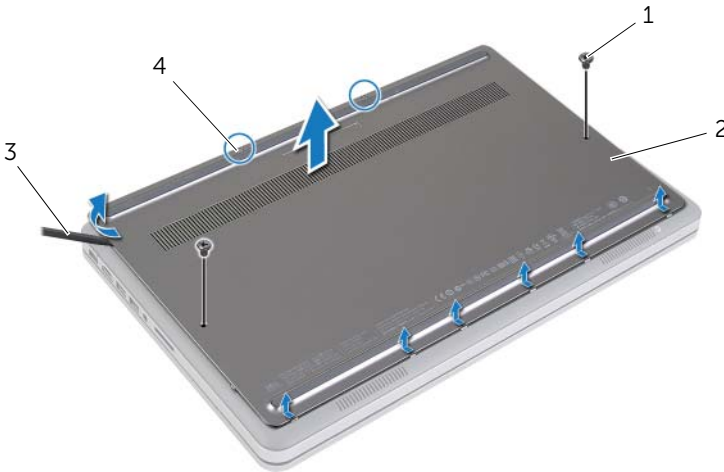

---

1	screws (2)	2	base cover
3	plastic scribe	4	captive screws (2)

---

# Replacing the Base Cover

---



**WARNING:** Before working inside your computer, read the safety information that shipped with your computer and follow the steps in "Before Working Inside Your Computer" on page 7. After working inside your computer, follow the instructions in "After Working Inside Your Computer" on page 9.

For more safety best practices, see the Regulatory Compliance home page at [dell.com/regulatory\\_compliance](https://dell.com/regulatory_compliance).

## Procedure

- 1 Slide the tabs on the base cover into the bottom cover and snap the base cover into place.
- 2 Replace the screws that secure the base cover to the bottom cover.
- 3 Tighten the captive screws that secure the base cover to the bottom cover.
- 4 Turn the computer over, open the display, and turn on the computer.

# Removing the Battery

**⚠ WARNING:** Before working inside your computer, read the safety information that shipped with your computer and follow the steps in "Before Working Inside Your Computer" on page 7. After working inside your computer, follow the instructions in "After Working Inside Your Computer" on page 9. For more safety best practices, see the Regulatory Compliance home page at [dell.com/regulatory\\_compliance](http://dell.com/regulatory_compliance).

## Prerequisites

Remove the base cover. See "Removing the Base Cover" on page 10.

## Procedure

- 1 Remove the screws that secure the battery to the bottom cover.
- 2 Using the pull-tab, lift the battery off the bottom cover.

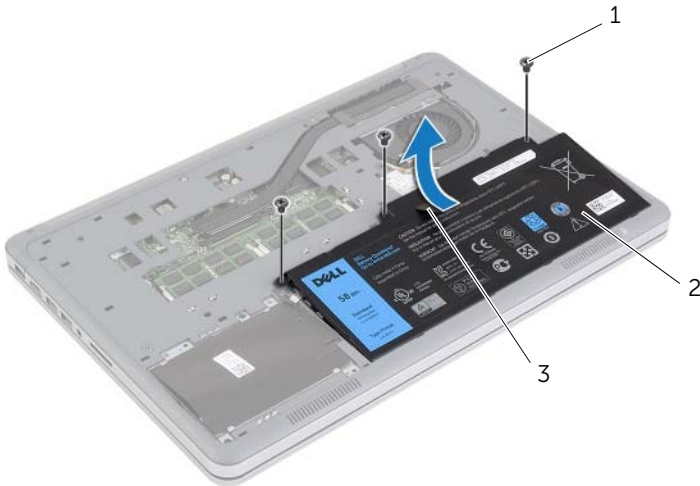

---

1 screws (3)

2 battery

---

3 pull tab

---

- 3 Turn the computer over, open the display, and press the power button for about five seconds to ground the system board.

# Replacing the Battery

---



**WARNING:** Before working inside your computer, read the safety information that shipped with your computer and follow the steps in "Before Working Inside Your Computer" on page 7. After working inside your computer, follow the instructions in "After Working Inside Your Computer" on page 9. For more safety best practices, see the Regulatory Compliance home page at [dell.com/regulatory\\_compliance](http://dell.com/regulatory_compliance).

## Procedure

- 1 Align the screw holes on the battery with the screw holes on the bottom cover and press on the battery to connect it to the system board.
- 2 Replace the screws that secure the battery to the bottom cover.

## Postrequisites

Replace the base cover. See "Replacing the Base Cover" on page 11.

# Removing the Memory Module(s)

---

**⚠ WARNING:** Before working inside your computer, read the safety information that shipped with your computer and follow the steps in "Before Working Inside Your Computer" on page 7. After working inside your computer, follow the instructions in "After Working Inside Your Computer" on page 9. For more safety best practices, see the Regulatory Compliance home page at [dell.com/regulatory\\_compliance](http://dell.com/regulatory_compliance).

## Prerequisites

- 1 Remove the base cover. See "Removing the Base Cover" on page 10.
- 2 Remove the battery. See "Removing the Battery" on page 12.

## Procedure

- 1 Use your fingertips to carefully spread apart the securing-clips on each end of the memory-module connector until the memory module pops up.
- 2 Remove the memory module from the memory-module connector.

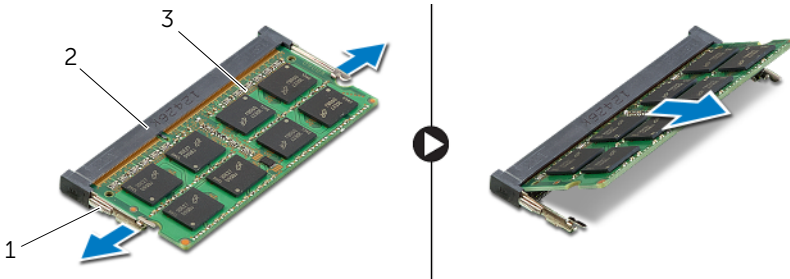

---

1	securing-clips (2)	2	memory-module connector
3	memory module		

---

# Replacing the Memory Module(s)

---



**WARNING:** Before working inside your computer, read the safety information that shipped with your computer and follow the steps in "Before Working Inside Your Computer" on page 7. After working inside your computer, follow the instructions in "After Working Inside Your Computer" on page 9.

For more safety best practices, see the Regulatory Compliance home page at [dell.com/regulatory\\_compliance](http://dell.com/regulatory_compliance).

## Procedure

- 1 Align the notch on the memory module with the tab on the memory-module connector.
- 2 Slide the memory module firmly into the connector at a 45-degree angle and press the memory module down until it clicks into place.



**NOTE:** If you do not hear the click, remove the memory module and reinstall it.

## Postrequisites

- 1 Replace the battery. See "Replacing the Battery" on page 13.
- 2 Replace the base cover. See "Replacing the Base Cover" on page 11.

# Removing the Hard Drive

---

**⚠ WARNING:** Before working inside your computer, read the safety information that shipped with your computer and follow the steps in "Before Working Inside Your Computer" on page 7. After working inside your computer, follow the instructions in "After Working Inside Your Computer" on page 9. For more safety best practices, see the Regulatory Compliance home page at [dell.com/regulatory\\_compliance](http://dell.com/regulatory_compliance).

**⚠ CAUTION:** To avoid data loss, do not remove the hard drive while the computer is in Sleep or On state.

**⚠ CAUTION:** Hard drives are extremely fragile. Exercise care when handling the hard drive.

## Prerequisites

- 1 Remove the base cover. See "Removing the Base Cover" on page 10.
- 2 Remove the battery. See "Removing the Battery" on page 12.

## Procedure

- 1 Remove the screws that secure the hard-drive assembly to the bottom cover.
- 2 Using the pull-tab, carefully lift the hard-drive assembly and then disconnect the hard-drive cable.

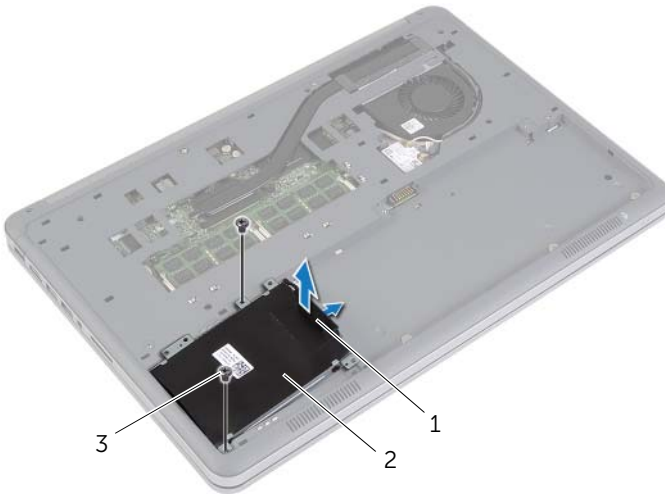

---

1 pull-tab

2 hard-drive assembly

---

3 screws (2)

---



- 3 Remove the screws that secure the hard drive to the hard-drive bracket.
- 4 Lift the hard-drive bracket off the hard drive.

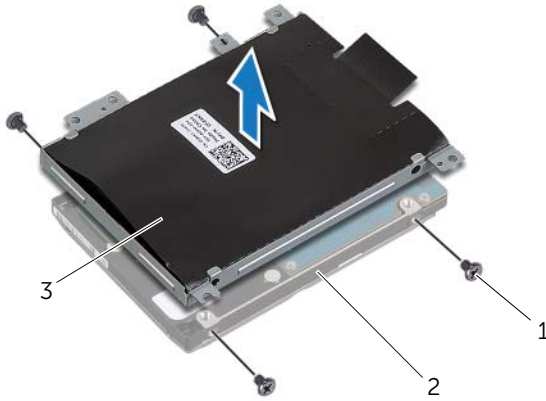

---

1	screws (4)	2	hard drive
---	------------	---	------------

---

3	hard-drive bracket
---	--------------------

---

# Replacing the Hard Drive

---



**WARNING:** Before working inside your computer, read the safety information that shipped with your computer and follow the steps in "Before Working Inside Your Computer" on page 7. After working inside your computer, follow the instructions in "After Working Inside Your Computer" on page 9. For more safety best practices, see the Regulatory Compliance home page at [dell.com/regulatory\\_compliance](http://dell.com/regulatory_compliance).



**CAUTION:** To avoid data loss, do not remove the hard drive while the computer is in Sleep or On state.



**CAUTION:** Hard drives are extremely fragile. Exercise care when handling the hard drive.

## Procedure

- 1 Align the screw holes on the hard drive with the screw holes on the hard-drive bracket.
- 2 Replace the screws that secure the hard drive to the hard-drive bracket.
- 3 Connect the hard-drive cable to the hard-drive assembly.
- 4 Align the screw holes on the hard-drive assembly with the screw holes on the bottom cover.
- 5 Replace the screws that secure the hard-drive assembly to the bottom cover.

## Postrequisites

- 1 Replace the battery. See "Replacing the Battery" on page 13.
- 2 Replace the base cover. See "Replacing the Base Cover" on page 11.

# Removing the Wireless Card

**⚠ WARNING:** Before working inside your computer, read the safety information that shipped with your computer and follow the steps in "Before Working Inside Your Computer" on page 7. After working inside your computer, follow the instructions in "After Working Inside Your Computer" on page 9. For more safety best practices, see the Regulatory Compliance home page at [dell.com/regulatory\\_compliance](http://dell.com/regulatory_compliance).

## Prerequisites

- 1 Remove the base cover. See "Removing the Base Cover" on page 10.
- 2 Remove the battery. See "Removing the Battery" on page 12.

## Procedure

- 1 Disconnect the antenna cables from the wireless card.
- 2 Remove the screw that secures the wireless card to the system board.
- 3 Remove the wireless card from the system board.

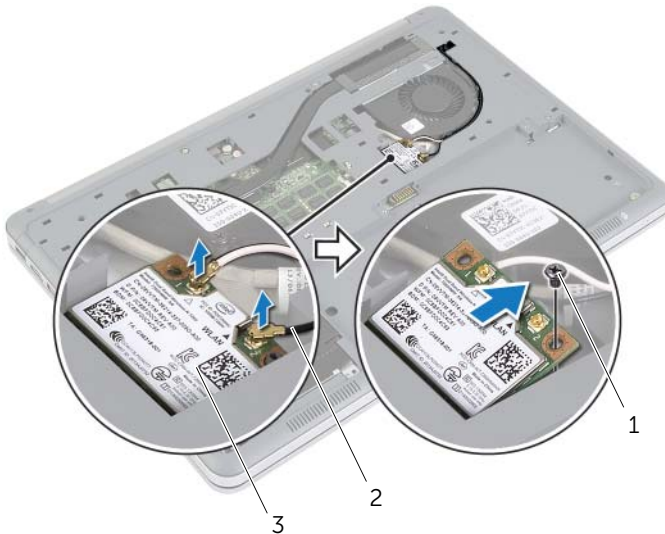

1 screw

2 antenna cables (2)

3 wireless card

# Replacing the Wireless Card

---

 **WARNING:** Before working inside your computer, read the safety information that shipped with your computer and follow the steps in "Before Working Inside Your Computer" on page 7. After working inside your computer, follow the instructions in "After Working Inside Your Computer" on page 9. For more safety best practices, see the Regulatory Compliance home page at [dell.com/regulatory\\_compliance](http://dell.com/regulatory_compliance).

## Procedure

 **CAUTION:** To avoid damage to the wireless card, do not place any cables under it.

- 1 Align the notch on the wireless card with the tab on the wireless-card connector.
- 2 Press the wireless card down into the slot on the system board and replace the screw that secures the wireless card to the system board.
- 3 Connect the antenna cables to the wireless card.

 **NOTE:** The color of the antenna cables is visible near the tip of the cables.

The following table provides the antenna-cable color scheme for the wireless card supported by your computer.

Connectors on the wireless card	Antenna-cable color
Main (white triangle)	white
Auxiliary (black triangle)	black

## Postrequisites

- 1 Replace the battery. See "Replacing the Battery" on page 13.
- 2 Replace the base cover. See "Replacing the Base Cover" on page 11.

# Removing the Keyboard

---

**!** **WARNING:** Before working inside your computer, read the safety information that shipped with your computer and follow the steps in "Before Working Inside Your Computer" on page 7. After working inside your computer, follow the instructions in "After Working Inside Your Computer" on page 9. For more safety best practices, see the Regulatory Compliance home page at [dell.com/regulatory\\_compliance](http://dell.com/regulatory_compliance).

## Prerequisites

- 1 Remove the base cover. See "Removing the Base Cover" on page 10.
- 2 Remove the battery. See "Removing the Battery" on page 12.

## Procedure

- 1 Remove the screw that secures the keyboard to the palm-rest assembly.

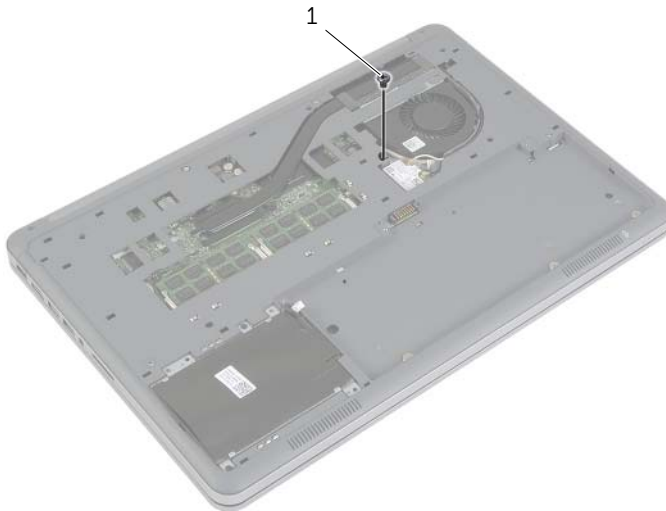

---

1 screw

---

- 2 Turn the computer over and open the display as far as possible.
- 3 Using a plastic scribe, release the latches that secure the keyboard to the palm-rest assembly.
- 4 Carefully turn the keyboard over and place it on the palm-rest assembly.

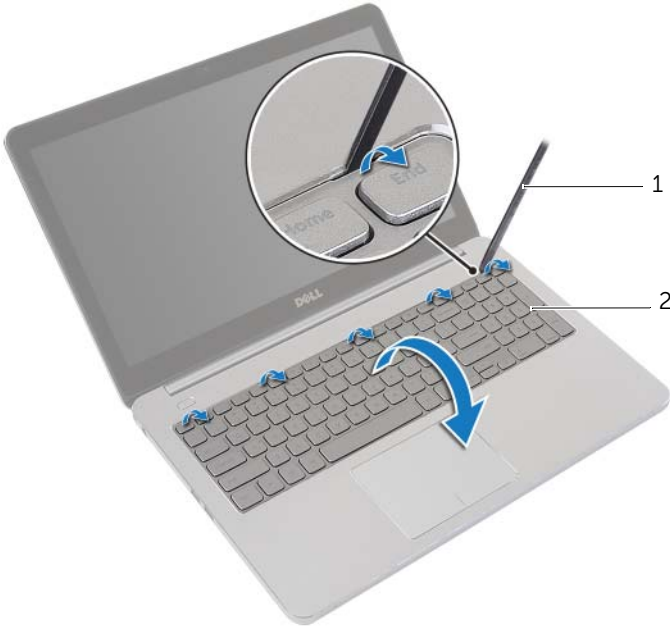

---

1 plastic scribe

2 keyboard

---

- 5 Lift the connector latches and disconnect the keyboard and keyboard-backlit cables from the system board.
- 6 Lift the keyboard off the palm-rest assembly.



---

1	keyboard-backlit cable	2	connector latches (2)
3	keyboard cable		

---

# Replacing the Keyboard

---



**WARNING:** Before working inside your computer, read the safety information that shipped with your computer and follow the steps in "Before Working Inside Your Computer" on page 7. After working inside your computer, follow the instructions in "After Working Inside Your Computer" on page 9.

For more safety best practices, see the Regulatory Compliance home page at [dell.com/regulatory\\_compliance](http://dell.com/regulatory_compliance).

## Procedure

- 1 Slide the keyboard and keyboard-backlit cables into the system board and press down the connector latches to secure the cables.
- 2 Carefully turn the keyboard over, slide the tabs on the keyboard into the slots on the palm-rest assembly, and snap the keyboard into place.
- 3 Close the display and turn the computer over.
- 4 Replace the screw that secures the keyboard to the palm-rest assembly.

## Postrequisites.

- 1 Replace the battery. See "Replacing the Battery" on page 13.
- 2 Replace the base cover. See "Replacing the Base Cover" on page 11.



# Removing the Bottom Cover

---



**WARNING:** Before working inside your computer, read the safety information that shipped with your computer and follow the steps in "Before Working Inside Your Computer" on page 7. After working inside your computer, follow the instructions in "After Working Inside Your Computer" on page 9.

For more safety best practices, see the Regulatory Compliance home page at [dell.com/regulatory\\_compliance](http://dell.com/regulatory_compliance).

## Prerequisites

- 1 Remove the base cover. See "Removing the Base Cover" on page 10.
- 2 Remove the battery. See "Removing the Battery" on page 12.
- 3 Remove the hard-drive. See "Removing the Hard Drive" on page 16.
- 4 Remove the wireless card. See "Removing the Wireless Card" on page 19.
- 5 Remove the keyboard. See "Removing the Keyboard" on page 21.

# Procedure

- 1 Remove the screws that secure the bottom cover to the palm-rest assembly.



---

1	screws (2)	2	palm-rest assembly
---	------------	---	--------------------

---

- 2 Close the display and turn the computer over.
- 3 Remove the screws that secure the bottom cover to the palm-rest assembly.
- 4 Note the antenna cables routing and remove them from the routing guides on the bottom cover.

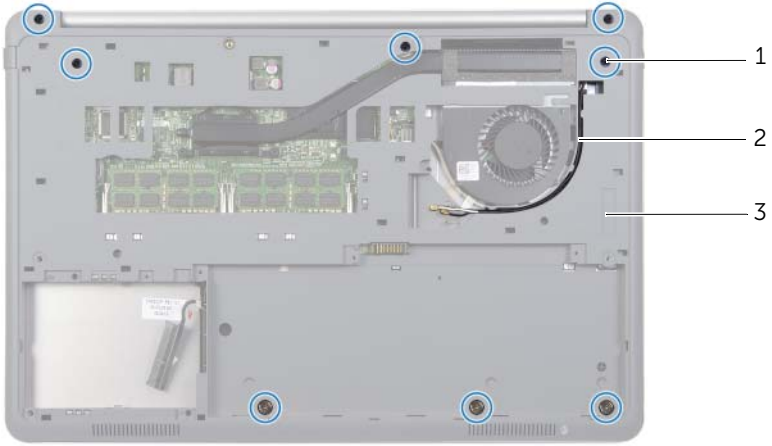

- 
- |   |              |   |                        |
|---|--------------|---|------------------------|
| 1 | screws (8)   | 2 | antenna cables routing |
| 3 | bottom cover |   |                        |
- 

- 5 Using a plastic scribe, pry the bottom cover off the palm-rest assembly.



- 
- |   |                |   |              |
|---|----------------|---|--------------|
| 1 | plastic scribe | 2 | bottom cover |
|---|----------------|---|--------------|
- 

- 6 Lift the bottom cover and remove the antenna cables from the slot on the bottom cover.

# Replacing the Bottom Cover

---



**WARNING:** Before working inside your computer, read the safety information that shipped with your computer and follow the steps in "Before Working Inside Your Computer" on page 7. After working inside your computer, follow the instructions in "After Working Inside Your Computer" on page 9.

For more safety best practices, see the Regulatory Compliance home page at [dell.com/regulatory\\_compliance](http://dell.com/regulatory_compliance).

## Procedure

- 1 Route the antenna cables through the guides on the bottom cover.
- 2 Align the tabs on the bottom cover with the slots on the palm-rest assembly and snap the bottom cover into place.
- 3 Replace the screws that secure the bottom cover to the palm-rest assembly.
- 4 Turn the computer over and open the display as far as possible.
- 5 Replace the screws that secure the bottom cover to the palm-rest assembly.

## Postrequisites

- 1 Replace the keyboard. See "Replacing the Keyboard" on page 24.
- 2 Replace the wireless card. See "Replacing the Wireless Card" on page 20.
- 3 Replace the hard drive. See "Replacing the Hard Drive" on page 18.
- 4 Replace the battery. See "Replacing the Battery" on page 13.
- 5 Replace the base cover. See "Replacing the Base Cover" on page 11.

# Removing the Coin-Cell Battery

---

- ⚠ WARNING:** Before working inside your computer, read the safety information that shipped with your computer and follow the steps in "Before Working Inside Your Computer" on page 7. After working inside your computer, follow the instructions in "After Working Inside Your Computer" on page 9. For more safety best practices, see the Regulatory Compliance home page at [dell.com/regulatory\\_compliance](http://dell.com/regulatory_compliance).
- ⚠ CAUTION:** Removing the coin-cell battery resets the BIOS settings to default. It is recommended that you note the BIOS settings before removing the coin-cell battery.

## Prerequisites

- 1 Remove the base cover. See "Removing the Base Cover" on page 10.
- 2 Remove the battery. See "Removing the Battery" on page 12.
- 3 Remove the hard-drive. See "Removing the Hard Drive" on page 16.
- 4 Remove the wireless card. See "Removing the Wireless Card" on page 19.
- 5 Remove the keyboard. See "Removing the Keyboard" on page 21.
- 6 Remove the bottom cover. See "Removing the Bottom Cover" on page 25.

## Procedure

Using a plastic scribe, gently pry out the coin-cell battery out of the battery socket on the system board.



---

1 plastic scribe

2 coin-cell battery

---

# Replacing the Coin-Cell Battery

---

 **WARNING:** Before working inside your computer, read the safety information that shipped with your computer and follow the steps in "Before Working Inside Your Computer" on page 7. After working inside your computer, follow the instructions in "After Working Inside Your Computer" on page 9. For more safety best practices, see the Regulatory Compliance home page at [dell.com/regulatory\\_compliance](http://dell.com/regulatory_compliance).

 **WARNING:** The battery may explode if installed incorrectly. Replace the battery only with the same or equivalent type. Discard used batteries according to the manufacturer's instructions.

## Procedure

With the positive-side facing up, snap the coin-cell battery into the battery socket on the system board.

## Postrequisites

- 1 Replace the bottom cover. See "Replacing the Bottom Cover" on page 28.
- 2 Replace the keyboard. See "Replacing the Keyboard" on page 24.
- 3 Replace the wireless card. See "Replacing the Wireless Card" on page 20.
- 4 Replace the hard drive. See "Replacing the Hard Drive" on page 18.
- 5 Replace the battery. See "Replacing the Battery" on page 13.
- 6 Replace the base cover. See "Replacing the Base Cover" on page 11.

# Removing the Speakers

---



**WARNING:** Before working inside your computer, read the safety information that shipped with your computer and follow the steps in "Before Working Inside Your Computer" on page 7. After working inside your computer, follow the instructions in "After Working Inside Your Computer" on page 9.

For more safety best practices, see the Regulatory Compliance home page at [dell.com/regulatory\\_compliance](http://dell.com/regulatory_compliance).

## Prerequisites

- 1 Remove the base cover. See "Removing the Base Cover" on page 10.
- 2 Remove the battery. See "Removing the Battery" on page 12.
- 3 Remove the hard-drive. See "Removing the Hard Drive" on page 16.
- 4 Remove the wireless card. See "Removing the Wireless Card" on page 19.
- 5 Remove the keyboard. See "Removing the Keyboard" on page 21.
- 6 Remove the bottom cover. See "Removing the Bottom Cover" on page 25.

# Procedure

- 1 Using a plastic scribe, release the tabs on the right speaker.
- 2 Release the tabs that secure the left speaker to the palm-rest assembly.
- 3 Disconnect the speaker cable from the system board.
- 4 Remove the speaker cable from the routing guides on the palm-rest assembly.
- 5 Lift the speakers along with its cable off the palm-rest assembly.

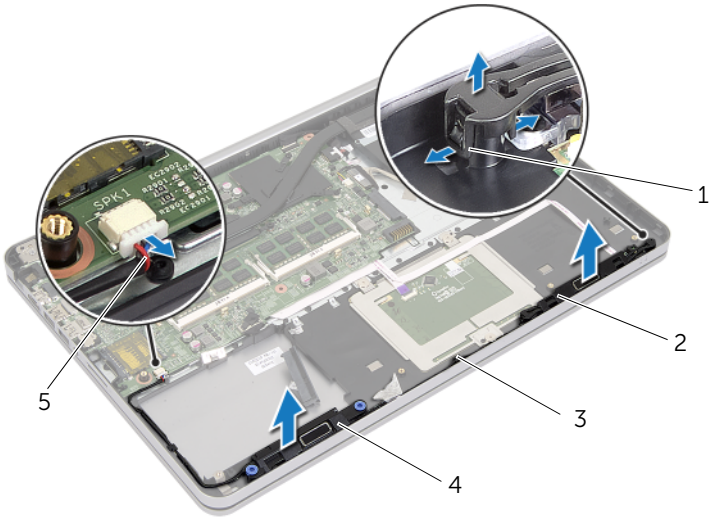

1	tabs	2	left speaker
3	routing guide	4	right speaker
5	speaker cable		



# Replacing the Speakers

---



**WARNING:** Before working inside your computer, read the safety information that shipped with your computer and follow the steps in "Before Working Inside Your Computer" on page 7. After working inside your computer, follow the instructions in "After Working Inside Your Computer" on page 9.

For more safety best practices, see the Regulatory Compliance home page at [dell.com/regulatory\\_compliance](http://dell.com/regulatory_compliance).

## Procedure

- 1 Align the push pins on the left speaker with the slots on the palm-rest assembly and snap the left speaker into place.
- 2 Route the speaker cable through the routing guides on the palm-rest assembly.
- 3 Align the right speaker on the alignment posts and snap the right speaker into place.
- 4 Connect the speaker cable to the system board.

## Postrequisites

- 1 Replace the bottom cover. See "Replacing the Bottom Cover" on page 28.
- 2 Replace the keyboard. See "Replacing the Keyboard" on page 24.
- 3 Replace the wireless card. See "Replacing the Wireless Card" on page 20.
- 4 Replace the hard drive. See "Replacing the Hard Drive" on page 18.
- 5 Replace the battery. See "Replacing the Battery" on page 13.
- 6 Replace the base cover. See "Replacing the Base Cover" on page 11.

# Removing the Thermal-Cooling Assembly

---



**WARNING:** Before working inside your computer, read the safety information that shipped with your computer and follow the steps in "Before Working Inside Your Computer" on page 7. After working inside your computer, follow the instructions in "After Working Inside Your Computer" on page 9.

For more safety best practices, see the Regulatory Compliance home page at [dell.com/regulatory\\_compliance](http://dell.com/regulatory_compliance).

## Prerequisites

- 1 Remove the base cover. See "Removing the Base Cover" on page 10.
- 2 Remove the battery. See "Removing the Battery" on page 12.
- 3 Remove the hard-drive. See "Removing the Hard Drive" on page 16.
- 4 Remove the wireless card. See "Removing the Wireless Card" on page 19.
- 5 Remove the keyboard. See "Removing the Keyboard" on page 21.
- 6 Remove the bottom cover. See "Removing the Bottom Cover" on page 25.

# Procedure

**NOTE:** The number of screws and the shape of the thermal-cooling assembly vary for systems shipping with integrated graphics card.

- 1 Disconnect the fan cable from the system board.
- 2 In sequential order (indicated on the thermal-cooling assembly), loosen the captive screws that secure the thermal-cooling assembly to the system board.
- 3 Lift the thermal-cooling assembly off the palm-rest assembly.

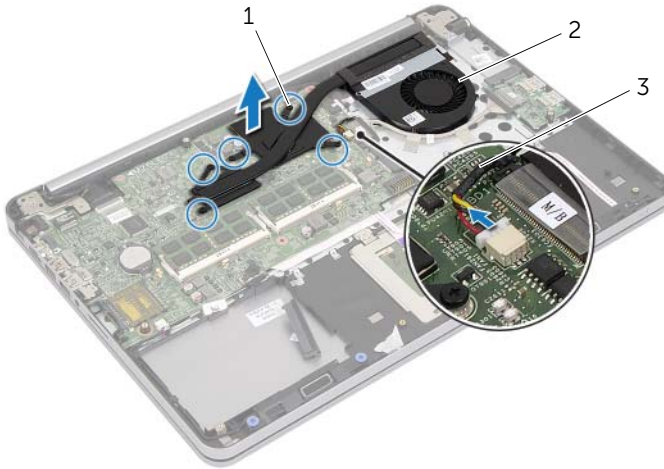

1	captive screws (5)	2	thermal-cooling assembly
3	fan cable		

# Replacing the Thermal-Cooling Assembly

---



**WARNING:** Before working inside your computer, read the safety information that shipped with your computer and follow the steps in "Before Working Inside Your Computer" on page 7. After working inside your computer, follow the instructions in "After Working Inside Your Computer" on page 9. For more safety best practices, see the Regulatory Compliance home page at [dell.com/regulatory\\_compliance](http://dell.com/regulatory_compliance).

## Procedure



**NOTE:** The original thermal grease can be reused, if the original system board and thermal-cooling assembly are reinstalled together. If either the system board or the thermal-cooling assembly is replaced, use the thermal pad provided in the kit to make sure that thermal conductivity is achieved.

- 1 Align the screws on the thermal-cooling assembly with the screw holes on the system board.
- 2 In sequential order (indicated on the thermal-cooling assembly), tighten the captive screws that secure the thermal-cooling assembly to the system board.
- 3 Connect the fan cable to the system board.

## Postrequisites

- 1 Replace the bottom cover. See "Replacing the Bottom Cover" on page 28.
- 2 Replace the keyboard. See "Replacing the Keyboard" on page 24.
- 3 Replace the wireless card. See "Replacing the Wireless Card" on page 20.
- 4 Replace the hard drive. See "Replacing the Hard Drive" on page 18.
- 5 Replace the battery. See "Replacing the Battery" on page 13.
- 6 Replace the base cover. See "Replacing the Base Cover" on page 11.

# Removing the USB Board

**⚠ WARNING:** Before working inside your computer, read the safety information that shipped with your computer and follow the steps in "Before Working Inside Your Computer" on page 7. After working inside your computer, follow the instructions in "After Working Inside Your Computer" on page 9. For more safety best practices, see the Regulatory Compliance home page at [dell.com/regulatory\\_compliance](http://dell.com/regulatory_compliance).

## Prerequisites

- 1 Remove the base cover. See "Removing the Base Cover" on page 10.
- 2 Remove the battery. See "Removing the Battery" on page 12.
- 3 Remove the hard-drive. See "Removing the Hard Drive" on page 16.
- 4 Remove the wireless card. See "Removing the Wireless Card" on page 19.
- 5 Remove the keyboard. See "Removing the Keyboard" on page 21.
- 6 Remove the bottom cover. See "Removing the Bottom Cover" on page 25.

## Procedure

- 1 Peel off the tape that secures the USB-board cable to the USB board.
- 2 Lift the latch and disconnect the USB-board cable from the USB board.
- 3 Lift the USB board off the palm-rest assembly.

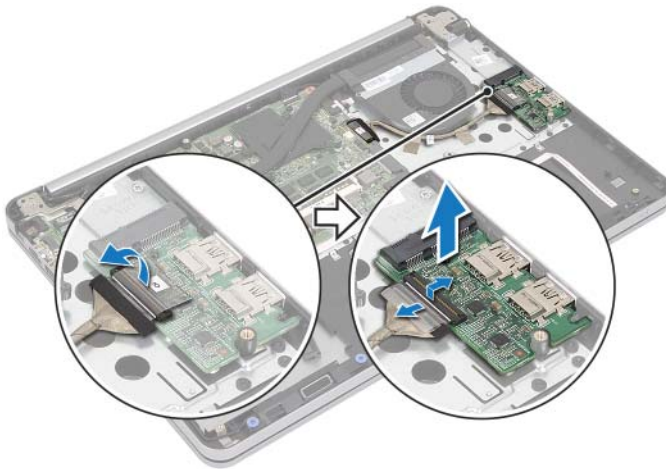

1	USB board	2	alignment post
3	connector latch	4	securing tape
5	USB-board cable		

# Replacing the USB Board

---



**WARNING:** Before working inside your computer, read the safety information that shipped with your computer and follow the steps in "Before Working Inside Your Computer" on page 7. After working inside your computer, follow the instructions in "After Working Inside Your Computer" on page 9. For more safety best practices, see the Regulatory Compliance home page at [dell.com/regulatory\\_compliance](http://dell.com/regulatory_compliance).

## Procedure

- 1 Using the alignment posts, place the USB board on the palm-rest assembly.
- 2 Slide the USB-board cable into the USB-board connector and press down on the connector latch to secure the cable.
- 3 Adhere the tape that secures the USB-board cable to the USB board.

## Postrequisites

- 1 Replace the bottom cover. See "Replacing the Bottom Cover" on page 28.
- 2 Replace the keyboard. See "Replacing the Keyboard" on page 24.
- 3 Replace the wireless card. See "Replacing the Wireless Card" on page 20.
- 4 Replace the hard drive. See "Replacing the Hard Drive" on page 18.
- 5 Replace the battery. See "Replacing the Battery" on page 13.
- 6 Replace the base cover. See "Replacing the Base Cover" on page 11.

# Removing the Power-Adapter Port

---

**⚠ WARNING:** Before working inside your computer, read the safety information that shipped with your computer and follow the steps in "Before Working Inside Your Computer" on page 7. After working inside your computer, follow the instructions in "After Working Inside Your Computer" on page 9. For more safety best practices, see the Regulatory Compliance home page at [dell.com/regulatory\\_compliance](http://dell.com/regulatory_compliance).

## Prerequisites

- 1 Remove the base cover. See "Removing the Base Cover" on page 10.
- 2 Remove the battery. See "Removing the Battery" on page 12.
- 3 Remove the hard-drive. See "Removing the Hard Drive" on page 16.
- 4 Remove the wireless card. See "Removing the Wireless Card" on page 19.
- 5 Remove the keyboard. See "Removing the Keyboard" on page 21.
- 6 Remove the bottom cover. See "Removing the Bottom Cover" on page 25.
- 7 Remove the thermal-cooling assembly. See "Removing the Thermal-Cooling Assembly" on page 34.

## Procedure

- 1 Remove the screws that secure the display hinge to the palm-rest assembly.

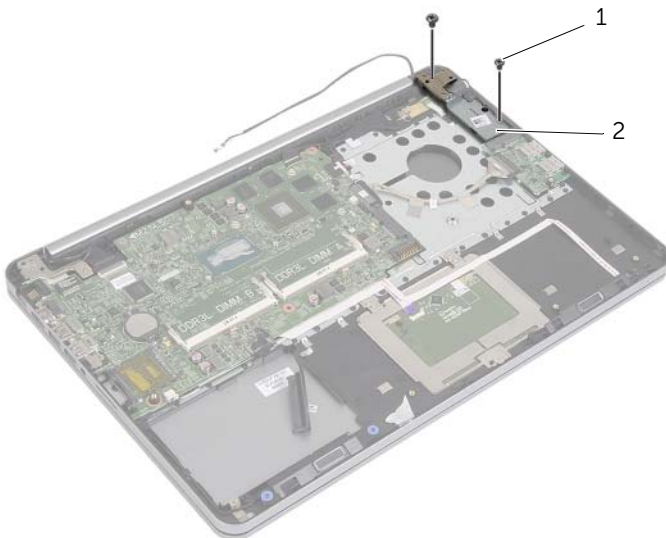

---

1 screws (2)

2 display hinge

---



**CAUTION: Be careful when handling the palm-rest assembly. Failure to do so could result in scratching the display panel.**

- 2 Open the palm-rest assembly as far as possible to release the display hinge from the palm-rest assembly and close the palm-rest assembly.

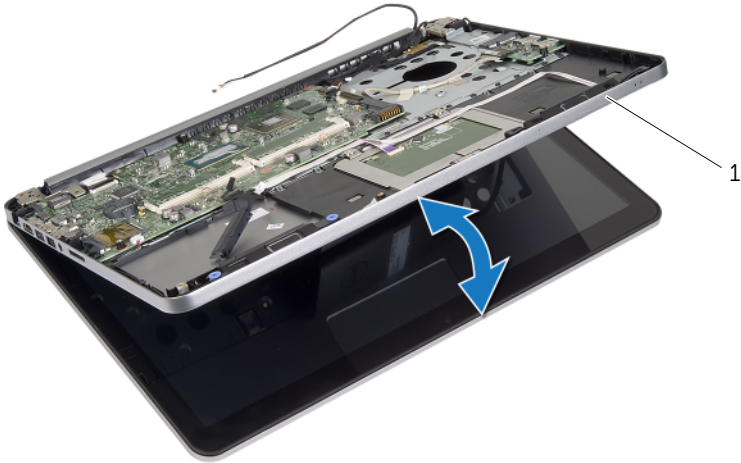

---

1 palm-rest assembly

---



- 3 Remove the screw that secures the power-button board to the palm-rest assembly.
- 4 Remove the power-button board from the power-adaptor port cable routing.

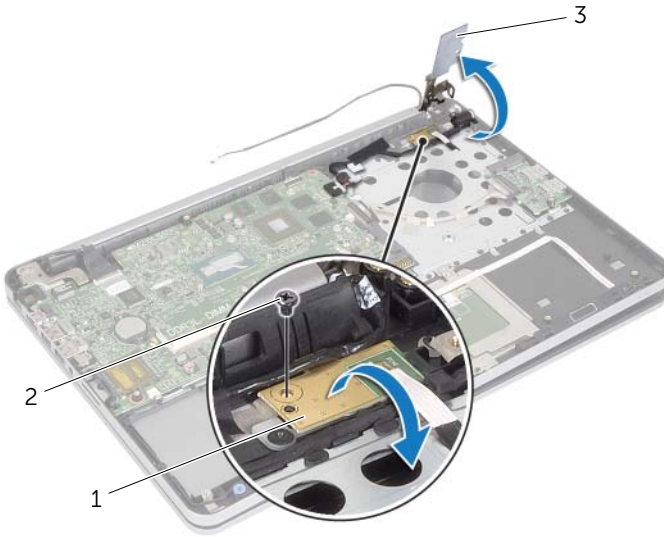

---

1	power-button board	2	screw
---	--------------------	---	-------

---

3	display hinge
---	---------------

---

- 5 Note the power-adapter port cable routing and remove the cable from the routing guides.
- 6 Remove the screw that secure the power-adapter port to the palm-rest assembly.
- 7 Peel off the tape that secures the power-adapter port cable to the palm-rest assembly.
- 8 Disconnect the power-adapter port cable from the system board.
- 9 Lift the power-adapter port off the palm-rest assembly.

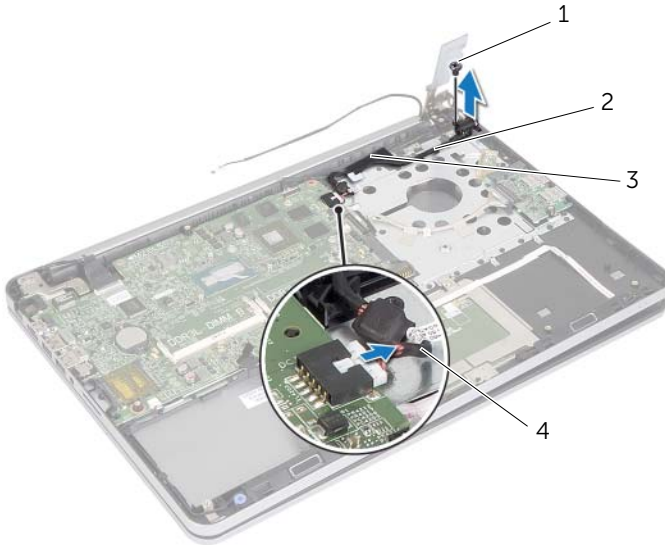

1	screw	2	power-adapter port cable routing
3	tape	4	power-adapter port cable

# Replacing the Power-Adapter Port

---



**WARNING:** Before working inside your computer, read the safety information that shipped with your computer and follow the steps in "Before Working Inside Your Computer" on page 7. After working inside your computer, follow the instructions in "After Working Inside Your Computer" on page 9.

For more safety best practices, see the Regulatory Compliance home page at [dell.com/regulatory\\_compliance](http://dell.com/regulatory_compliance).

## Procedure

- 1 Align the screw hole on the power-adapter port with the screw hole on the palm-rest assembly.
- 2 Replace the screw that secures the power-adapter port to the palm-rest assembly.
- 3 Route the power-adapter port cable through the routing guides on the palm-rest assembly.
- 4 Adhere the tape to the power-adapter port cable.
- 5 Connect the power-adapter port cable to the system board.
- 6 Align the screw hole on the power-button board with the screw hole on the palm-rest assembly.
- 7 Replace the screw that secures the power-button board to the palm-rest assembly.
- 8 Press down the display hinge into position.
- 9 Replace the screws that secure the display hinge to palm-rest assembly.

## Postrequisites

- 1 Replace the thermal-cooling assembly. See "Replacing the Thermal-Cooling Assembly" on page 36.
- 2 Replace the bottom cover. See "Replacing the Bottom Cover" on page 28.
- 3 Replace the keyboard. See "Replacing the Keyboard" on page 24.
- 4 Replace the wireless card. See "Replacing the Wireless Card" on page 20.
- 5 Replace the hard drive. See "Replacing the Hard Drive" on page 18.
- 6 Replace the battery. See "Replacing the Battery" on page 13.
- 7 Replace the base cover. See "Replacing the Base Cover" on page 11.

# Removing the System Board

---



**WARNING:** Before working inside your computer, read the safety information that shipped with your computer and follow the steps in "Before Working Inside Your Computer" on page 7. After working inside your computer, follow the instructions in "After Working Inside Your Computer" on page 9.

For more safety best practices, see the Regulatory Compliance home page at [dell.com/regulatory\\_compliance](http://dell.com/regulatory_compliance).

## Prerequisites

- 1 Remove the base cover. See "Removing the Base Cover" on page 10.
- 2 Remove the battery. See "Removing the Battery" on page 12.
- 3 Remove the memory. See "Removing the Memory Module(s)" on page 14.
- 4 Remove the wireless card. See "Removing the Wireless Card" on page 19.
- 5 Remove the keyboard. See "Removing the Keyboard" on page 21.
- 6 Remove the bottom cover. See "Removing the Bottom Cover" on page 25.
- 7 Remove the coin-cell battery. See "Removing the Coin-Cell Battery" on page 29.
- 8 Remove the thermal-cooling assembly. See "Removing the Thermal-Cooling Assembly" on page 34.

# Procedure

**NOTE:** Replacing the system board removes any changes you have made to the BIOS using System Setup. Enter the Service Tag of your computer in the BIOS and make the desired changes again after you replace the system board. For more information on entering the Service Tag in the BIOS, see "Replacing the System Board" on page 49.

**NOTE:** Before disconnecting the cables from the system board, note the location of the connectors so that you can reconnect them correctly after you replace the system board.

- 1 Turn the computer over and open the display as far as possible.
- 2 Lift the connector latches and disconnect the touchpad cable, status-light cable, and power-button cable from the system board.



1	power-button cable	2	connector latches (3)
3	touchpad cable	4	status-lights cable

- 3 Close the display and turn the computer over.
- 4 Disconnect the power-adaptor port cable, speaker cable, camera cable, and hard-drive cable from the system board.
- 5 Peel off the tapes and lift the connector latches that secure the display and USB-board cables to the system board.

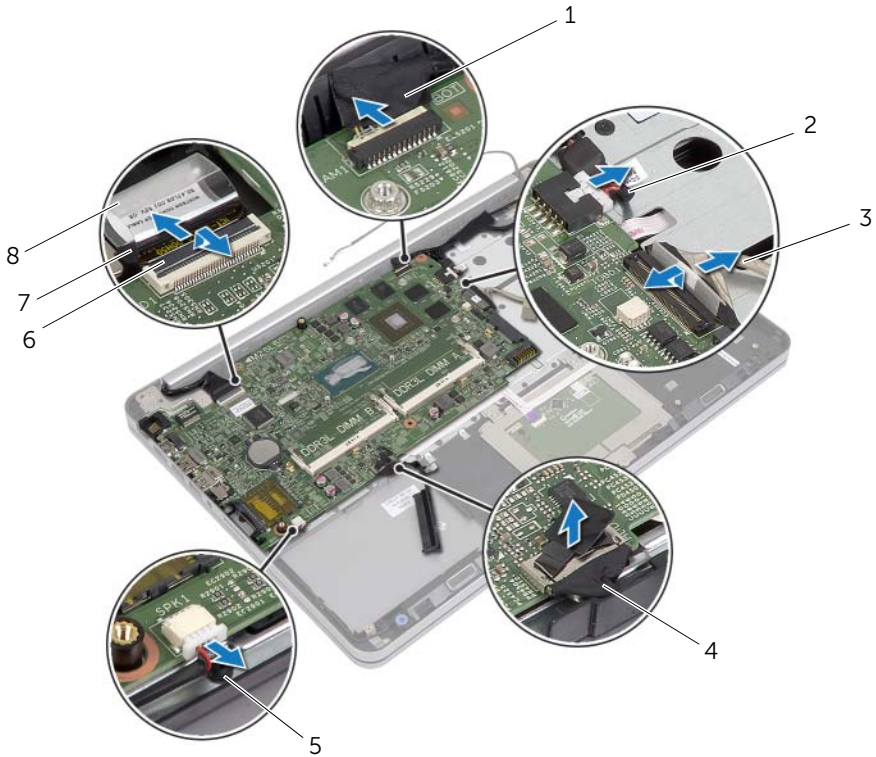

1	camera cable	2	power-adaptor port cable
3	USB-board cable	4	hard-drive cable
5	speakers cable	6	connector latch
7	display cable	8	tape

- 6 Remove the screw that secures the system board to the palm-rest assembly.
- 7 Remove the screw that secures the display hinge to the palm-rest assembly.

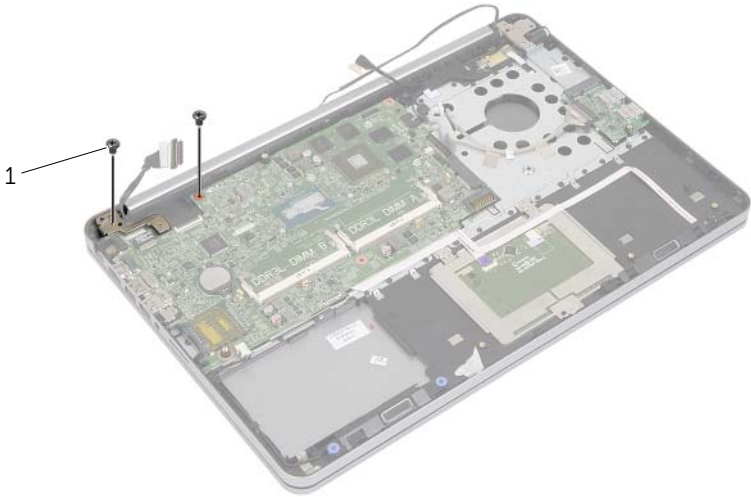

---

1 screws (2)

---

- 8 Open the palm-rest assembly as far as possible to release the display hinge from the palm-rest assembly.

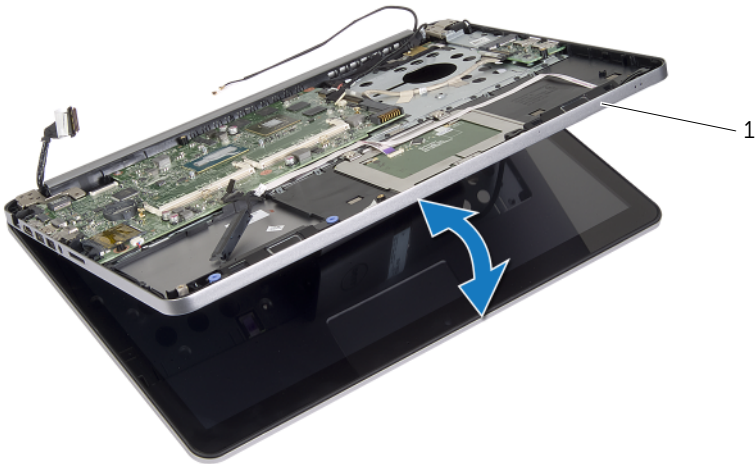

---

1 palm-rest assembly

---

- 9 Lift the system board at an angle and release the headset port from the slot on the palm-rest assembly.
- 10 Lift the system board off the palm-rest assembly.



---

1 system board

---



# Replacing the System Board

---

 **WARNING:** Before working inside your computer, read the safety information that shipped with your computer and follow the steps in "Before Working Inside Your Computer" on page 7. After working inside your computer, follow the instructions in "After Working Inside Your Computer" on page 9. For more safety best practices, see the Regulatory Compliance home page at [dell.com/regulatory\\_compliance](http://dell.com/regulatory_compliance).

## Procedure

 **CAUTION:** Make sure that no cables are placed under the system board.

- 1 Slide the headset port into the slot on the palm-rest assembly and align the screw holes on the system board with the screw holes on the palm-rest assembly.
- 2 Press down the display hinge into position.
- 3 Replace the screw that secures the display hinge to the palm-rest assembly.
- 4 Replace the screw that secures the system board to the palm-rest assembly.
- 5 Slide the display and USB-board cables into the system board and press down on the connector latches to secure the cables.
- 6 Adhere the tapes to the display and USB-board cables.
- 7 Connect the power-adaptor port cable, speaker cable, camera cable, and hard-drive cable to the system board.
- 8 Turn the computer over and open the display as far as possible.
- 9 Slide the touchpad and status-lights cables into the system board and press down on the connector latches to secure the cables.

## Postrequisites

- 1 Replace the thermal-cooling assembly. See "Replacing the Thermal-Cooling Assembly" on page 36.
- 2 Replace the coin-cell battery. See "Replacing the Coin-Cell Battery" on page 30.
- 3 Replace the bottom cover. See "Replacing the Bottom Cover" on page 28.
- 4 Replace the keyboard. See "Replacing the Keyboard" on page 24.
- 5 Replace the wireless card. See "Replacing the Wireless Card" on page 20.
- 6 Replace the memory. See "Replacing the Memory Module(s)" on page 15.
- 7 Replace the battery. See "Replacing the Battery" on page 13.
- 8 Replace the base cover. See "Replacing the Base Cover" on page 11.

## Entering the Service Tag in the BIOS

- 1 Turn on the computer.
- 2 At the Dell logo, press <F2> to enter System Setup.
- 3 Navigate to the **Main** tab and type the Service Tag in the **Service Tag** field.

# Removing the Display Assembly

---



**WARNING:** Before working inside your computer, read the safety information that shipped with your computer and follow the steps in "Before Working Inside Your Computer" on page 7. After working inside your computer, follow the instructions in "After Working Inside Your Computer" on page 9.

For more safety best practices, see the Regulatory Compliance home page at [dell.com/regulatory\\_compliance](http://dell.com/regulatory_compliance).

## Prerequisites

- 1 Remove the base cover. See "Removing the Base Cover" on page 10.
- 2 Remove the battery. See "Removing the Battery" on page 12.
- 3 Remove the memory. See "Removing the Memory Module(s)" on page 14.
- 4 Remove the wireless card. See "Removing the Wireless Card" on page 19.
- 5 Remove the keyboard. See "Removing the Keyboard" on page 21.
- 6 Remove the bottom cover. See "Removing the Bottom Cover" on page 25.

# Procedure

- 1 Peel off the tape, lift the latch, and disconnect the display cable from the system board.
- 2 Disconnect the camera cable from the system board.
- 3 Peel the tape off the camera cable.
- 4 Note the camera cable routing and remove the cable from the routing guides on the palm-rest assembly.
- 5 Remove the screws that secure the display hinges to the palm-rest assembly.

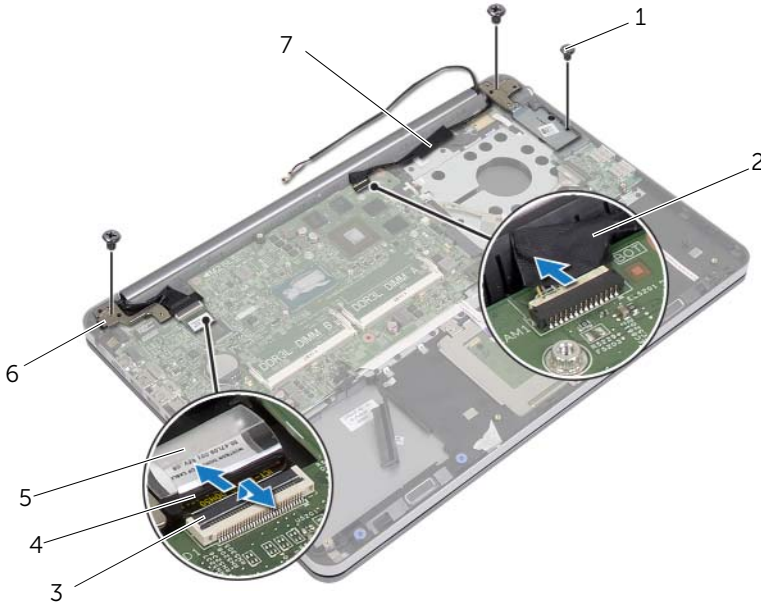

1	screws (3)	2	tape
3	latch	4	display cable
5	tape	6	display hinges (2)
7	camera cable		

- 6 Open the palm-rest assembly to an angle of 90 degrees to release the display hinges from the palm-rest assembly.

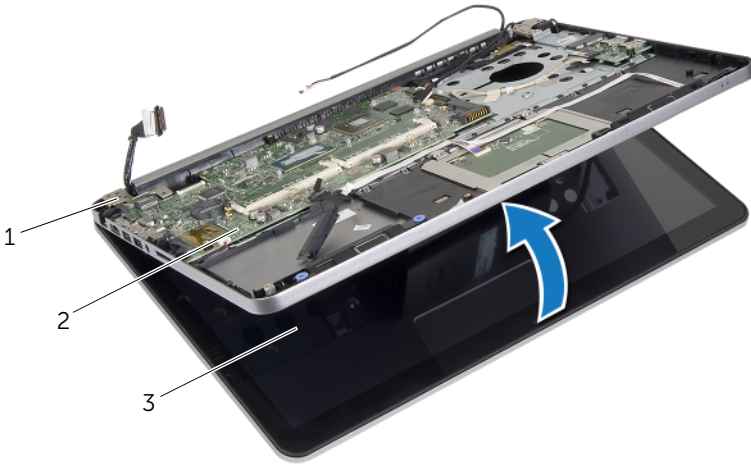

---

1 display hinges

2 palm-rest assembly

---

3 display assembly

---

7 Lift the palm-rest assembly away from the display assembly.

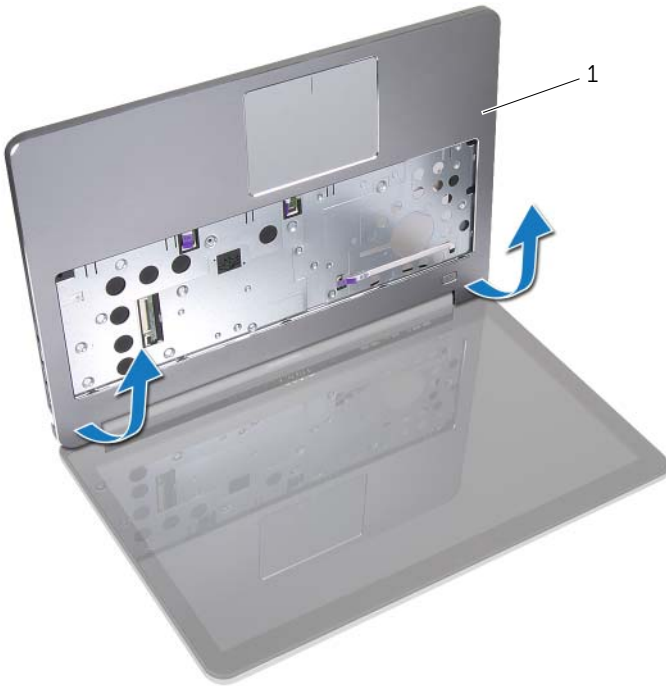

---

1 palm-rest assembly

---

# Replacing the Display Assembly

---



**WARNING:** Before working inside your computer, read the safety information that shipped with your computer and follow the steps in "Before Working Inside Your Computer" on page 7. After working inside your computer, follow the instructions in "After Working Inside Your Computer" on page 9. For more safety best practices, see the Regulatory Compliance home page at [dell.com/regulatory\\_compliance](http://dell.com/regulatory_compliance).

## Procedure

- 1 Place the palm-rest assembly on the display assembly.
- 2 Align the screw holes on the palm-rest assembly with the screw holes on the display hinges and pressing down on the display hinges close the palm-rest assembly.
- 3 Replace the screws that secure the display hinges to the palm-rest assembly.
- 4 Route the camera cable through the routing guides on the palm-rest assembly.
- 5 Adhere the tape to the camera cable.
- 6 Connect camera cable to the system board.
- 7 Slide the display cable into the system board and press down on the connector latch to secure the cable.
- 8 Adhere the tape to secure the display cable.

## Postrequisites

- 1 Replace the bottom cover. See "Replacing the Bottom Cover" on page 28.
- 2 Replace the keyboard. See "Replacing the Keyboard" on page 24.
- 3 Replace the wireless card. See "Replacing the Wireless Card" on page 20.
- 4 Replace the hard drive. See "Replacing the Hard Drive" on page 18.
- 5 Replace the battery. See "Replacing the Battery" on page 13.
- 6 Replace the base cover. See "Replacing the Base Cover" on page 11.

# Removing the Display Bezel

---



**WARNING:** Before working inside your computer, read the safety information that shipped with your computer and follow the steps in "Before Working Inside Your Computer" on page 7. After working inside your computer, follow the instructions in "After Working Inside Your Computer" on page 9.

For more safety best practices, see the Regulatory Compliance home page at [dell.com/regulatory\\_compliance](http://dell.com/regulatory_compliance).



**NOTE:** The below provided instructions are applicable only for computers with non-touch display.

## Prerequisites

- 1 Remove the base cover. See "Removing the Base Cover" on page 10.
- 2 Remove the battery. See "Removing the Battery" on page 12.
- 3 Remove the memory. See "Removing the Memory Module(s)" on page 14.
- 4 Remove the wireless card. See "Removing the Wireless Card" on page 19.
- 5 Remove the keyboard. See "Removing the Keyboard" on page 21.
- 6 Remove the bottom cover. See "Removing the Bottom Cover" on page 25.
- 7 Remove the display assembly. See "Removing the Display Assembly" on page 51.



# Procedure

- 1 Press the bottom of the display-hinge cover and remove it off the display assembly.



1 display assembly

2 display-hinge cover

- 2 Using your fingertips, carefully pry up the inside edge of the display bezel.
- 3 Remove the display bezel off the display back-cover.

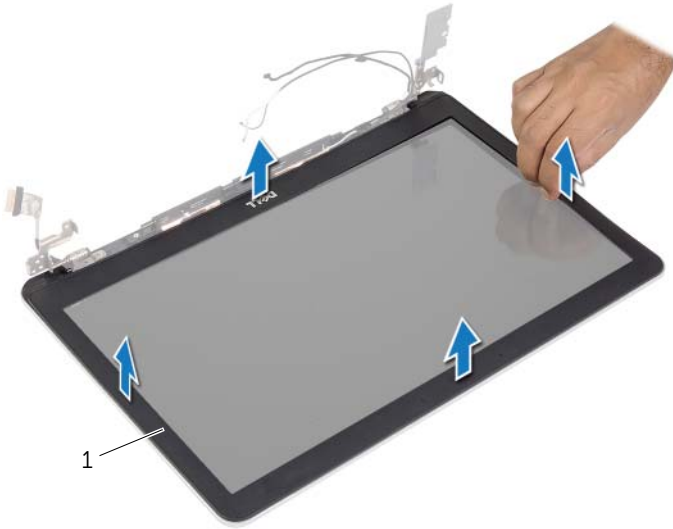

---

1 display bezel

---

# Replacing the Display Bezel

---



**WARNING:** Before working inside your computer, read the safety information that shipped with your computer and follow the steps in "Before Working Inside Your Computer" on page 7. After working inside your computer, follow the instructions in "After Working Inside Your Computer" on page 9.

For more safety best practices, see the Regulatory Compliance home page at [dell.com/regulatory\\_compliance](http://dell.com/regulatory_compliance).



**NOTE:** The below provided instructions are applicable only for computers with non-touch display.

## Procedure

- 1 Align the display bezel with the display back-cover, and gently snap the display bezel into place.
- 2 Press the bottom of the display-hinge cover and snap it into place.

## Postrequisites

- 1 Replace the display assembly. See "Replacing the Display Assembly" on page 55.
- 2 Replace the bottom cover. See "Replacing the Bottom Cover" on page 28.
- 3 Replace the keyboard. See "Replacing the Keyboard" on page 24.
- 4 Replace the wireless card. See "Replacing the Wireless Card" on page 20.
- 5 Replace the hard drive. See "Replacing the Hard Drive" on page 18.
- 6 Replace the battery. See "Replacing the Battery" on page 13.
- 7 Replace the base cover. See "Replacing the Base Cover" on page 11.

# Removing the Display Panel

---



**WARNING:** Before working inside your computer, read the safety information that shipped with your computer and follow the steps in "Before Working Inside Your Computer" on page 7. After working inside your computer, follow the instructions in "After Working Inside Your Computer" on page 9.

For more safety best practices, see the Regulatory Compliance home page at [dell.com/regulatory\\_compliance](http://dell.com/regulatory_compliance).



**NOTE:** The below provided instructions are applicable only for computers with non-touch display.

## Prerequisites

- 1 Remove the base cover. See "Removing the Base Cover" on page 10.
- 2 Remove the battery. See "Removing the Battery" on page 12.
- 3 Remove the memory. See "Removing the Memory Module(s)" on page 14.
- 4 Remove the wireless card. See "Removing the Wireless Card" on page 19.
- 5 Remove the keyboard. See "Removing the Keyboard" on page 21.
- 6 Remove the bottom cover. See "Removing the Bottom Cover" on page 25.
- 7 Remove the display assembly. See "Removing the Display Assembly" on page 51.
- 8 Remove the display bezel. See "Removing the Display Bezel" on page 56.

## Procedure

- 1 Remove the screws that secure the display panel to the display back-cover.
- 2 Lift the display panel off the display back-cover and place it face down on a clean surface.

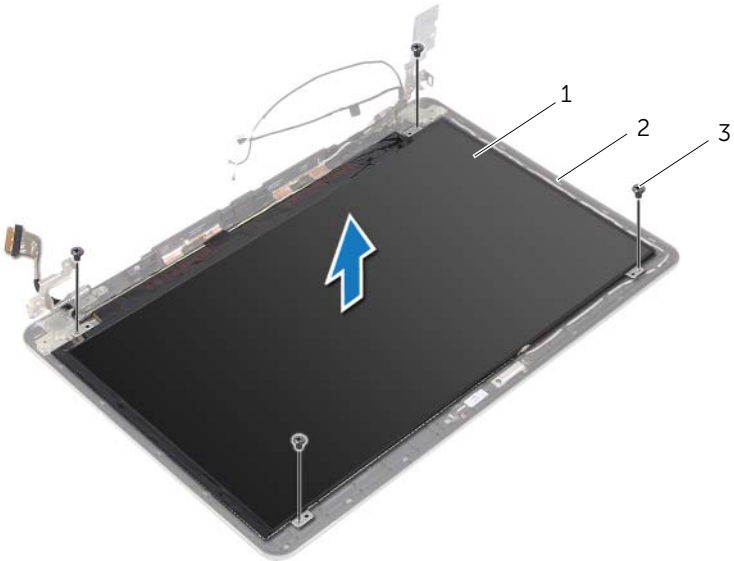

---

1 display panel

2 display back-cover

---

3 screws (4)

---

3 Peel off the tape and disconnect the display cable from the display panel.

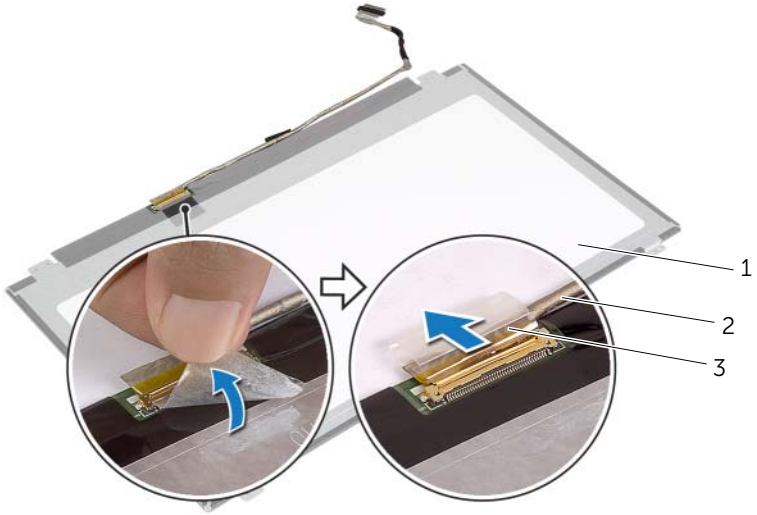

1 display panel

2 display cable

3 tape

# Replacing the Display Panel

---



**WARNING:** Before working inside your computer, read the safety information that shipped with your computer and follow the steps in "Before Working Inside Your Computer" on page 7. After working inside your computer, follow the instructions in "After Working Inside Your Computer" on page 9. For more safety best practices, see the Regulatory Compliance home page at [dell.com/regulatory\\_compliance](http://dell.com/regulatory_compliance).



**NOTE:** The below provided instructions are applicable only for computers with non-touch display.

## Procedure

- 1 Connect the display cable to the display panel and adhere the tape to secure the display cable.
- 2 Align the screw holes on the display panel with the screw holes on the display back-cover.
- 3 Replace the screws that secure the display panel to the display back-cover.

## Postrequisites

- 1 Replace the display bezel. See "Replacing the Display Bezel" on page 59.
- 2 Replace the display assembly. See "Replacing the Display Assembly" on page 55.
- 3 Replace the bottom cover. See "Replacing the Bottom Cover" on page 28.
- 4 Replace the keyboard. See "Replacing the Keyboard" on page 24.
- 5 Replace the wireless card. See "Replacing the Wireless Card" on page 20.
- 6 Replace the hard drive. See "Replacing the Hard Drive" on page 18.
- 7 Replace the battery. See "Replacing the Battery" on page 13.
- 8 Replace the base cover. See "Replacing the Base Cover" on page 11.

# Removing the Display Hinges

---



**WARNING:** Before working inside your computer, read the safety information that shipped with your computer and follow the steps in "Before Working Inside Your Computer" on page 7. After working inside your computer, follow the instructions in "After Working Inside Your Computer" on page 9.

For more safety best practices, see the Regulatory Compliance home page at [dell.com/regulatory\\_compliance](http://dell.com/regulatory_compliance).



**NOTE:** The below provided instructions are applicable only for computers with non-touch display.

## Prerequisites

- 1 Remove the base cover. See "Removing the Base Cover" on page 10.
- 2 Remove the battery. See "Removing the Battery" on page 12.
- 3 Remove the memory. See "Removing the Memory Module(s)" on page 14.
- 4 Remove the wireless card. See "Removing the Wireless Card" on page 19.
- 5 Remove the keyboard. See "Removing the Keyboard" on page 21.
- 6 Remove the bottom cover. See "Removing the Bottom Cover" on page 25.
- 7 Remove the display assembly. See "Removing the Display Assembly" on page 51.
- 8 Remove the display bezel. See "Removing the Display Bezel" on page 56.
- 9 Remove the display panel. See "Removing the Display Panel" on page 60.



# Procedure

- 1 Remove the screws that secure the display hinges to the display back-cover.
- 2 Remove the display hinges off the display back-cover.

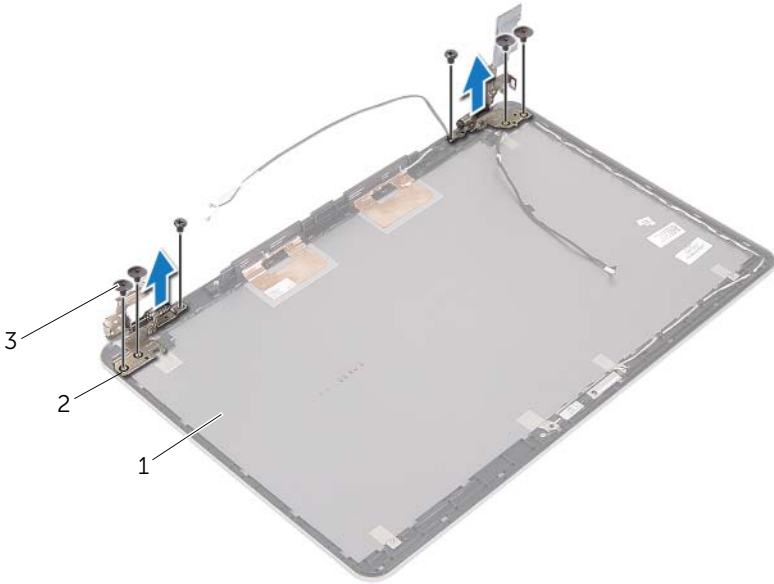

1	display back-cover	2	display hinges (2)
3	screws (6)		

# Replacing the Display Hinges

---



**WARNING:** Before working inside your computer, read the safety information that shipped with your computer and follow the steps in "Before Working Inside Your Computer" on page 7. After working inside your computer, follow the instructions in "After Working Inside Your Computer" on page 9. For more safety best practices, see the Regulatory Compliance home page at [dell.com/regulatory\\_compliance](http://dell.com/regulatory_compliance).



**NOTE:** The below provided instructions are applicable only for computers with non-touch display.

## Procedure

- 1 Align the screw holes on the display hinges with the screw holes on the display back-cover.
- 2 Replace the screws that secure the display hinges to the display back-cover.

## Postrequisites

- 1 Replace the display panel. See "Replacing the Display Panel" on page 63.
- 2 Replace the display bezel. See "Replacing the Display Bezel" on page 59.
- 3 Replace the display assembly. See "Replacing the Display Assembly" on page 55.
- 4 Replace the bottom cover. See "Replacing the Bottom Cover" on page 28.
- 5 Replace the keyboard. See "Replacing the Keyboard" on page 24.
- 6 Replace the wireless card. See "Replacing the Wireless Card" on page 20.
- 7 Replace the hard drive. See "Replacing the Hard Drive" on page 18.
- 8 Replace the battery. See "Replacing the Battery" on page 13.
- 9 Replace the base cover. See "Replacing the Base Cover" on page 11.

# Removing the Palm Rest

---



**WARNING:** Before working inside your computer, read the safety information that shipped with your computer and follow the steps in "Before Working Inside Your Computer" on page 7. After working inside your computer, follow the instructions in "After Working Inside Your Computer" on page 9.

For more safety best practices, see the Regulatory Compliance home page at [dell.com/regulatory\\_compliance](http://dell.com/regulatory_compliance).

## Prerequisites

- 1** Remove the base cover. See "Removing the Base Cover" on page 10.
- 2** Remove the battery. See "Removing the Battery" on page 12.
- 3** Remove the memory. See "Removing the Memory Module(s)" on page 14.
- 4** Remove the wireless card. See "Removing the Wireless Card" on page 19.
- 5** Remove the keyboard. See "Removing the Keyboard" on page 21.
- 6** Remove the bottom cover. See "Removing the Bottom Cover" on page 25.
- 7** Remove the coin-cell battery. See "Removing the Coin-Cell Battery" on page 29.
- 8** Remove the speakers. See "Removing the Speakers" on page 31.
- 9** Remove the thermal-cooling assembly. See "Removing the Thermal-Cooling Assembly" on page 34.
- 10** Remove the USB board. See "Removing the USB Board" on page 37.
- 11** Remove the power-adaptor port. See "Removing the Power-Adapter Port" on page 39.
- 12** Remove the system board. See "Removing the System Board" on page 44.

## Procedure

- 1 Open the palm rest assembly to an angle of 90 degrees to release the display hinges from the palm rest.

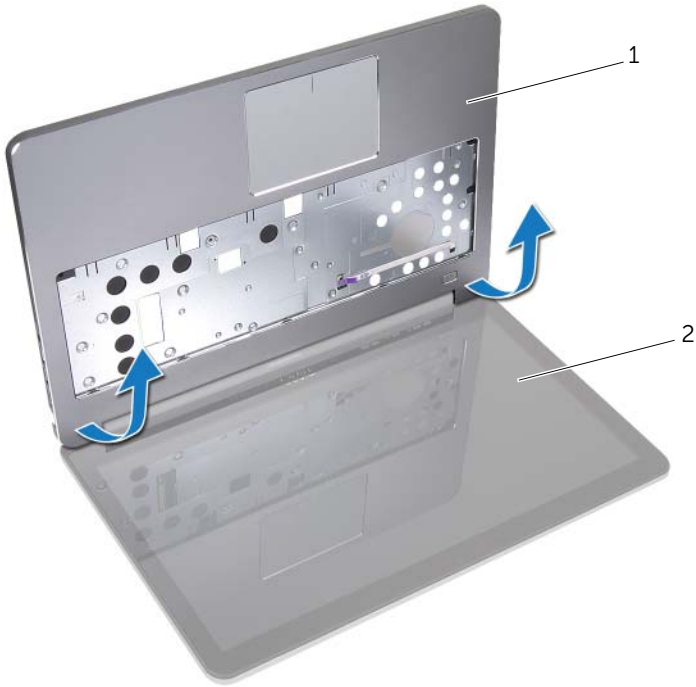

---

1 palm rest

2 display assembly

---

2 Remove the palm rest.



---

1 palm rest

---

# Replacing the Palm Rest

---



**WARNING:** Before working inside your computer, read the safety information that shipped with your computer and follow the steps in "Before Working Inside Your Computer" on page 7. After working inside your computer, follow the instructions in "After Working Inside Your Computer" on page 9. For more safety best practices, see the Regulatory Compliance home page at [dell.com/regulatory\\_compliance](http://dell.com/regulatory_compliance).

## Procedure

- 1 Place the palm rest on the display assembly.
- 2 Align the screw holes on the palm rest with the screw holes on the display hinges and pressing down on the display hinges close the palm rest.

## Postrequisites

- 1 Replace the bottom cover. See "Replacing the Bottom Cover" on page 28.
- 2 Replace the keyboard. See "Replacing the Keyboard" on page 24.
- 3 Replace the wireless card. See "Replacing the Wireless Card" on page 20.
- 4 Replace the hard drive. See "Replacing the Hard Drive" on page 18.
- 5 Replace the battery. See "Replacing the Battery" on page 13.
- 6 Replace the base cover. See "Replacing the Base Cover" on page 11.

# Flashing the BIOS

---

You may need to flash (update) the BIOS when an update is available or when you replace the system board. To flash the BIOS:

- 1 Turn on the computer.
- 2 Go to **dell.com/support**.
- 3 If you have your computer's Service Tag, type your computer's Service Tag and click **Submit**.

If you do not have your computer's Service Tag, click **Detect Service Tag** to allow automatic detection of the Service Tag.



**NOTE:** If the Service Tag cannot be detected automatically, select your product under the product categories.

- 4 Click **Drivers and Downloads**.
- 5 In the **Operating System** drop-down, select the operating system installed on your computer.
- 6 Click **BIOS**.
- 7 Click **Download File** to download the latest version of the BIOS for your computer.
- 8 On the next page, select **Single-file download** and click **Continue**.
- 9 Save the file and once the download is complete, navigate to the folder where you saved the BIOS update file.
- 10 Double-click the BIOS update file icon and follow the instructions on the screen.